



MP Monoblock Hip System

Surgical Technique

Explanation of Pictograms			
	Manufacturer		Article number
	Material number	Rx only	Caution: Federal law restricts this device to sale by or on the order of a physician.

MP Monoblock Hip System

02 System Description

- 02 System Description
- 03 Features

04 Surgical Technique

- 04 Preoperative Planning
- 04 Surgical Technique MP Monoblock Hip System

12 Implants

- 12 MP Monoblock Stems, standard and lateralized

14 Instruments

- 14 MP Monoblock Hip System, Basic Instruments
- 15 MP Reamers, complete
- 16 MP Monoblock Trial Stems, complete
- 18 Additional Instruments

19 Accessories/Literature

- 19 X-ray Templates
- 19 Instructions for Cleaning and Maintenance
- 19 Additional Literature

20 Indications/Contraindications

Important Information

System Description

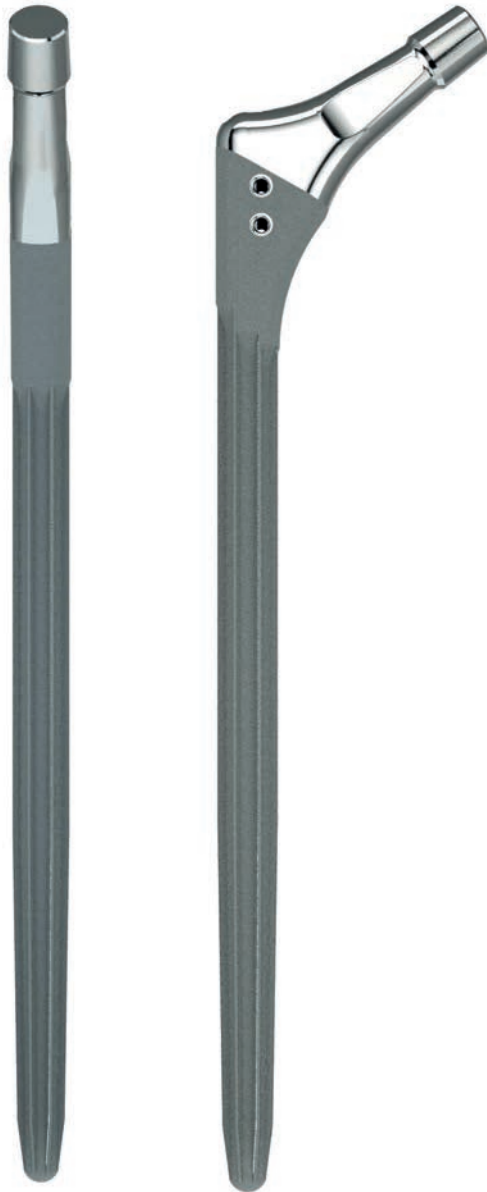

Going back to the proven design features of the MP Reconstruction system, the MP Monoblock is designed to meet the needs of modern revision surgery and completing the MP Family with a new versatility.

The MP 2° taper angle and proven, broad spline geometry give the stem a superior axial stability and lower the risk of subsidence. The rough PoroLink surface of the stem made from biocompatible Tilstan-S shall support the osseointegration and bone remodelling to provide long-term stability. Low risk of subsidence combined with a high offset version shall minimize the risk of luxation, while the short taper and flattened neck provide a great range of motion.

The surgical technique and instrumentation provides wide intraoperative versatility. The result is a system that allows the surgeon unlimited flexibility within the MP Family.

The instruments are designed to create a precise, reproducible relationship between the reamer, trial and implant positioning to help predict the ideal centre of rotation and support long-term stability of the hip joint.

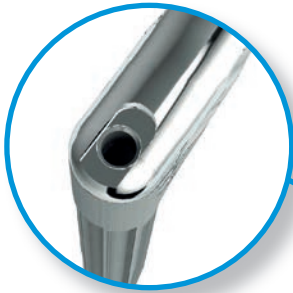

Guided insertion

fixed instrument connection
for full rotational control

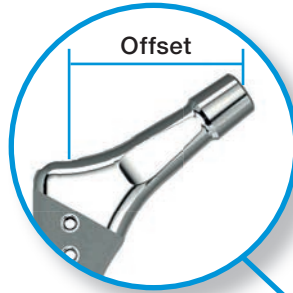

Neck portion

2 Offset options & CCD angles
A/P flattened & polished neck
short 12/14 taper



Suture holes

Ø 3mm suture holes
with smooth, polished edges

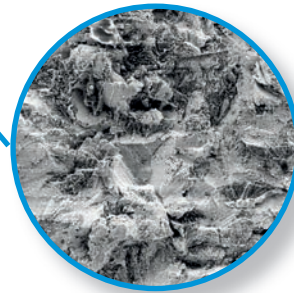

Surface

 PoroLink, rough, grit blasted
surface, 200x

Size range

3 stem lengths: 165mm,
195mm & 225mm
Ø 15mm - 25mm

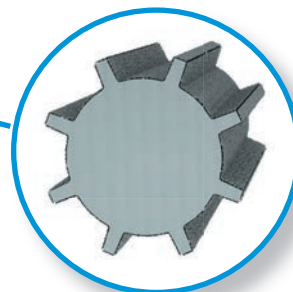

Distal stem portion

2° taper in the distal portion
8 to 10 ribs with broad,
tapered geometry

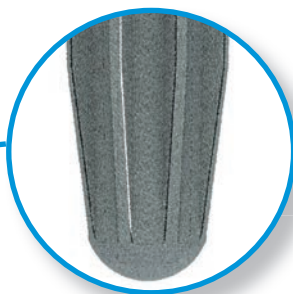

Rounded tip

The tips of the stems are rounded

Preoperative Planning

It is important to plan the intervention preoperatively in order to select the correct implant type and size and its final intraosseous position based on the patient's individual anatomy. The surgeon should perform a careful evaluation of the patient's clinical condition and consider the level of physical activity before performing a hip replacement.

For optimal results, the surgery should be planned in advance using the appropriate templates. The magnification factor of the X-rays must be compatible with the factor on the templates. Special MP Monoblock Hip System X-ray templates are available in standard 1.1:1.

The implant size must be chosen from adequate AP and ML X-rays with sufficient legibility. Each X-ray should be large enough for application of the whole template. A second X-ray of the unaffected joint is often helpful. Inadequate pre-operative planning can lead to improper selection of the implants and/or incorrect implant positioning.

INFORMATION:

Preoperative planning provides an initial estimation of the final situation but cannot conclusively determine the most adequate size to be used. The ultimate decision can only be taken intraoperatively.

As general rule, the prosthesis stem should be measured in such a way that a positive-fit anchoring of the prosthesis is created over a sufficient length in vital bone.

To this end, it is necessary to make allowance for reaming of the cortical bone. The reduction of the cortical wall thickness caused by the reaming should not exceed 1.5 mm in the planning.

Achieving anatomically appropriate head-neck length are of paramount importance. The MP Monoblock Hip System offers two offsets with changing CCD angles. This combined with femoral heads with up to four head-neck lengths allows the surgeon great flexibility.

Surgical Technique MP Monoblock

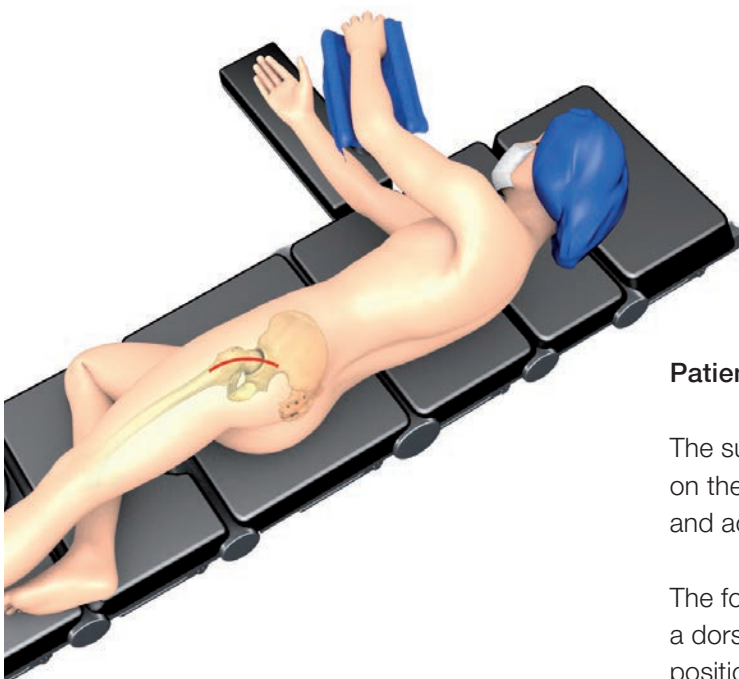

Patient positioning/Surgical approaches

The surgeon is free to choose the surgical approach on the basis of his/her experience and judgment, and according to the specific situation.

The following illustrations show the visualization with a dorsal approach and with the patient in the lateral position.



Fig. 1

Opening

After careful removal of the previous implant and any associated cement, the trochanter and proximal femur can be cleared with the Proximal Start Reamer, in order to allow an easy, axial access into the femoral canal (Fig. 1).

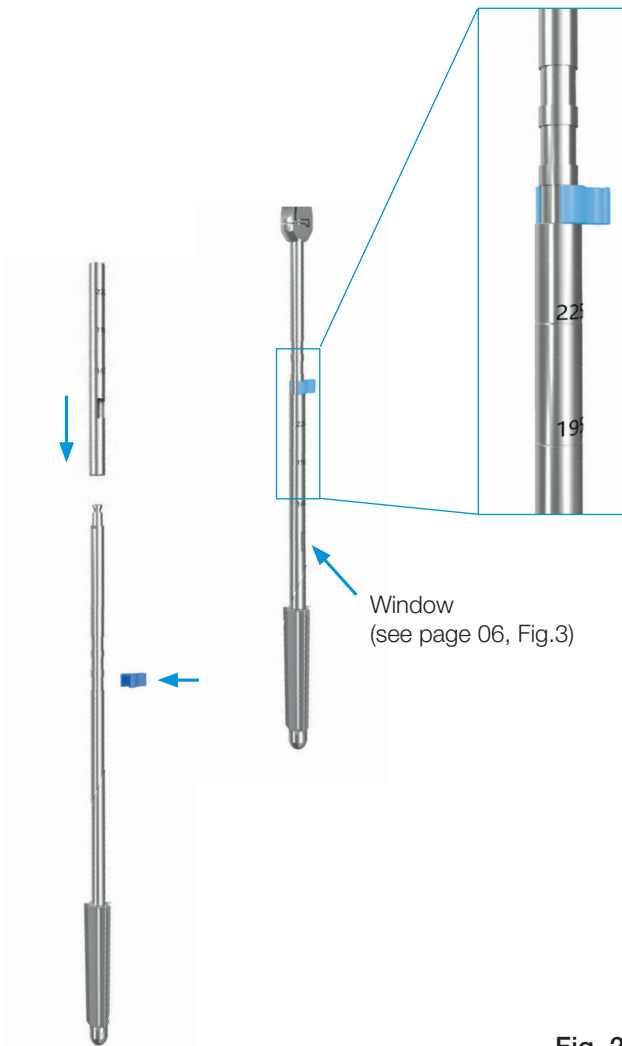

Fig. 2

Preparation of the femoral canal

Assemble the reamers by sliding the Reamer Sleeves over the Reamer shaft, so that the diameter of the Reamer can be seen through the window, and fixing them with the Sleeve Stopper (Fig 2).



Fig. 3

The medullary canal of the femur is gradually reamed by attaching the T-handle to the Reamer, starting with a size that is 4-5mm smaller than the templated size and reaming past the depth of the previous prosthetic bed.

There are engraved lines on the Reamer Sleeve that correspond to the head center of rotation of each implant length using a + 0mm femoral head. The Reamers are introduced to a depth where the mark that corresponds to the length of the stem is level with the tip of the greater trochanter (Fig. 3). The intended length and the diameter of the prosthesis is determined during pre-operative planning. However, the appropriate stem diameter has been reached when the resistance to reaming is markedly increased.

Trial Reduction

To assess leg length, abductor muscle tension and joint stability, perform a trial reduction with a trial range of motion using a trial stem and head. To assemble the Trial Prosthesis, three components are used 1) the Trial Stem in the prepared diameter 2) the Trial Neck that represents the stem lengths and 3) the Screw that is pre-assembled with the trial neck.

Based on the final Reamer diameter and the length, as indicated by the engraved line, assemble the Trial Stem as shown in Fig. 4. Use the Hex Screwdriver to tighten the Trial Neck onto the Trial Stem.

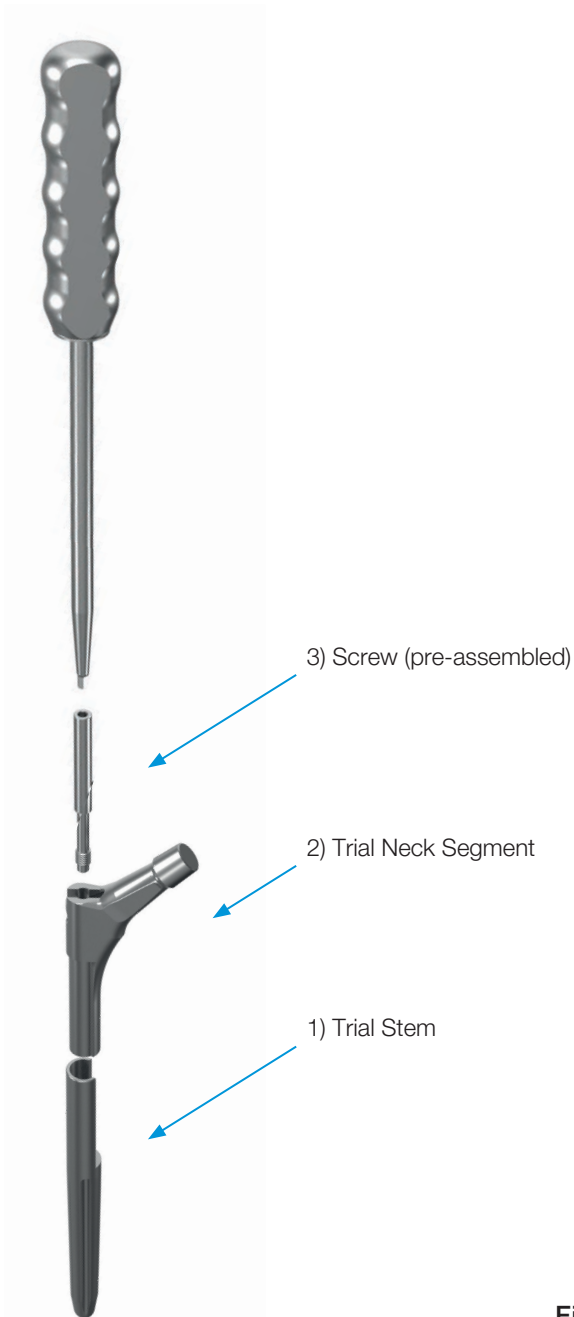

Fig. 4

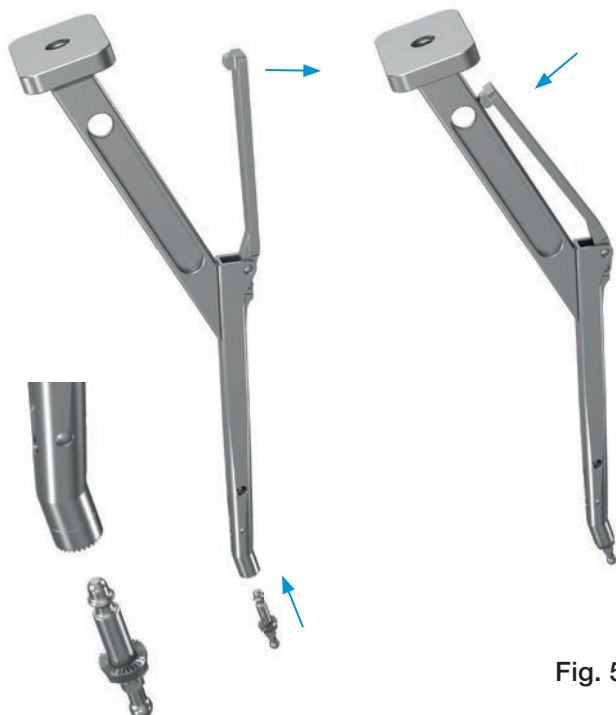

Fig. 5

Assemble the Trial Adapter with the impactor as shown in Fig. 5.

The assembled Trial Stem can now be placed by hand into the femoral canal as far as possible.

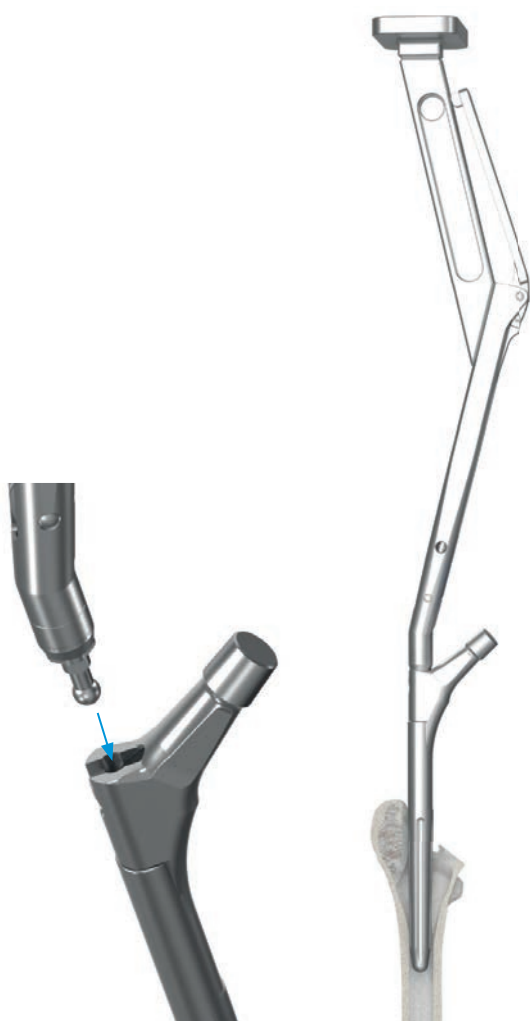

Fig. 6

To fully seat the Trial Stem, use the assembled Impactor + Trial Adapter by placing it in the oblong hole in the lateral shoulder of the Trial Stem, aligning the flanges to allow for rotational control. Then impact the Trial Stem with even hammer strokes until seated (Fig. 6).

The marking on the Impactor references to the center of rotation when a Trial Stem is assembled. The same line is also visible on the Reamer Sleeves. The Trial Stem must be driven in so far that the marking corresponds to the height to which the Reamer was referenced in the previous surgical step. In this case, the intended fit of the Trial Stem is correct.

The assembled Impactor + Trial Adapter is now removed.



Fig. 7

INFORMATION:

Usually, the acetabular cup is implanted before the stem component so that trial reduction can now be done.

Various Trial Heads are used to check for optimal offset, correct leg length and adequate stability. The range of motion is also checked in order to exclude any impingement of bone or implant with the acetabular cup, and to prevent any instability (Fig. 7).

INFORMATION:

The desired anteversion should then be marked on the bone so that the final implant can be positioned correctly.

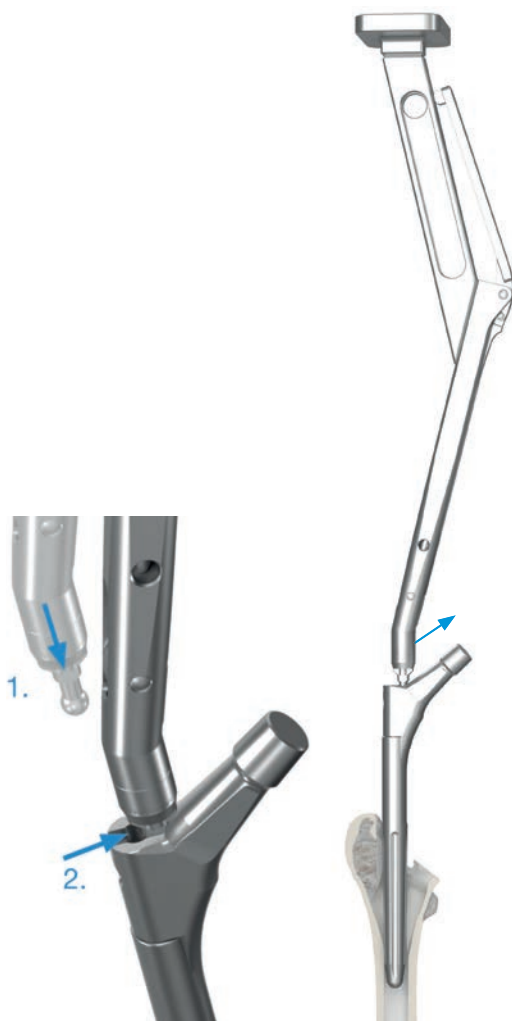

Fig. 8

Removal of the trial components

Finally, the Trial Head is removed. The Trial Stem is removed from the femoral canal using the assembled Impactor + Trial Adapter by inserting the ball on the tip of the adapter in the hole at the lateral shoulder and then sliding it up towards the neck. (Fig. 8)

During extraction, a slight tension must be kept on the Impactor, as it is coupled without a screw connection. This prevents the Trial Adapter from slipping.

INFORMATION:

Optionally, the Detachable Handle and the Slap Hammer (MP Reconstruction System, 317-661) can be screwed to the Impactor.

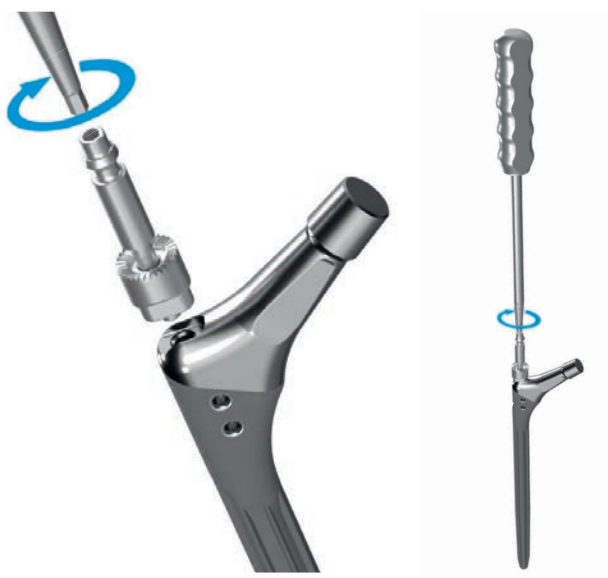

Fig. 9

Placing the final stem

The prosthesis stem to be used (size, CCD angle) was determined by means of the trial reduction performed previously. The corresponding implant is now removed from the sterile packaging and the Implant Adapter is fixed onto the threaded hole at the shoulder of the prosthesis, using the Hex Screwdriver. Before the screw is tightened, care must be taken, that the oblong nose of the Adapter is aligned with the oblong hole at the shoulder of the implant and fully engaged (Fig. 9).



Fig. 10

The Adapter with the implant is then connected to the Impactor.

INFORMATION:

The rigid connection between implant and impactor allows for rotational control when impacting the stem. This allows to implant the stem in the desired anteversion, assessed during trial reduction.

The revision prosthesis is placed in the prepared medullary cavity and driven into its definitive position with a few hammer strokes (Fig. 10).

The stability of the anchorage can be recognized in the following way:

- 1) the prosthesis penetrates somewhat deeper into the medullary cavity with each hammer stroke, until the required stability has been achieved and the prosthesis no longer moves under continued hammer strokes.
- 2) At the same time, the sound of the hammering changes to a higher pitch.



Fig. 11

Trial reduction

Another trial reduction can then be performed by placing the selected Trial Head onto the implant. Finally, the Trial Head is removed again (Fig. 11).



Fig. 12

Attaching the prosthesis head

The taper of the stem is carefully cleaned and dried. This is particularly important with ceramic heads. Then the head is attached by hand with a rotational movement, applying axial pressure. To finish, the Head Impactor is used to gently tap the prosthesis head into position (Fig. 12).

Final reduction of the joint

After cleaning the joint surfaces, the joint is reduced. The wound is closed in layers.

MP Monoblock Hip System, standard and lateralized

MAT Tilastan-S, Taper 12/14 mm

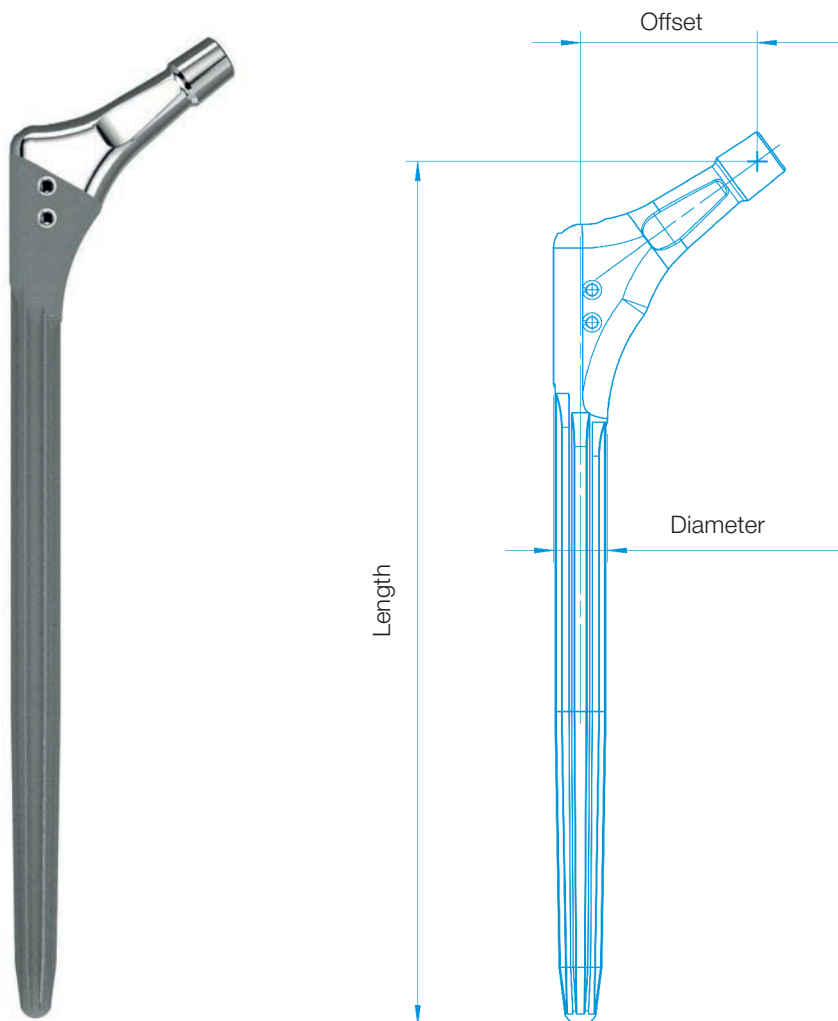

REF	Length mm	Diameter mm	Type	Offset mm
136-015/38	165	15	standard	38
136-016/38	165	16	standard	38
136-017/38	165	17	standard	38
136-015/46	165	15	lateralized	46
136-016/46	165	16	lateralized	46
136-017/46	165	17	lateralized	46
136-018/46	165	18	lateralized	46
136-019/46	165	19	lateralized	46
136-020/46	165	20	lateralized	46
136-021/46	165	21	lateralized	46

MP Monoblock Hip System, standard and lateralized**MAT** Tilastan-S, Taper 12/14 mm

REF	Length mm	Diameter mm	Type	Offset mm
136-115/38	195	15	standard	38
136-116/38	195	16	standard	38
136-117/38	195	17	standard	38
136-115/46	195	15	lateralized	46
136-116/46	195	16	lateralized	46
136-117/46	195	17	lateralized	46
136-118/46	195	18	lateralized	46
136-119/46	195	19	lateralized	46
136-120/46	195	20	lateralized	46
136-121/46	195	21	lateralized	46
136-122/46	195	22	lateralized	46
136-123/46	195	23	lateralized	46

REF	Length mm	Diameter mm	Type	Offset mm
136-215/38	225	15	standard	38
136-216/38	225	16	standard	38
136-217/38	225	17	standard	38
136-215/46	225	15	lateralized	46
136-216/46	225	16	lateralized	46
136-217/46	225	17	lateralized	46
136-218/46	225	18	lateralized	46
136-219/46	225	19	lateralized	46
136-220/46	225	20	lateralized	46
136-221/46	225	21	lateralized	46
136-222/46	225	22	lateralized	46
136-223/46	225	23	lateralized	46
136-224/46	225	24	lateralized	46
136-225/46	225	25	lateralized	46

136-030/00 MP Monoblock Hip System, Basic Instruments, complete

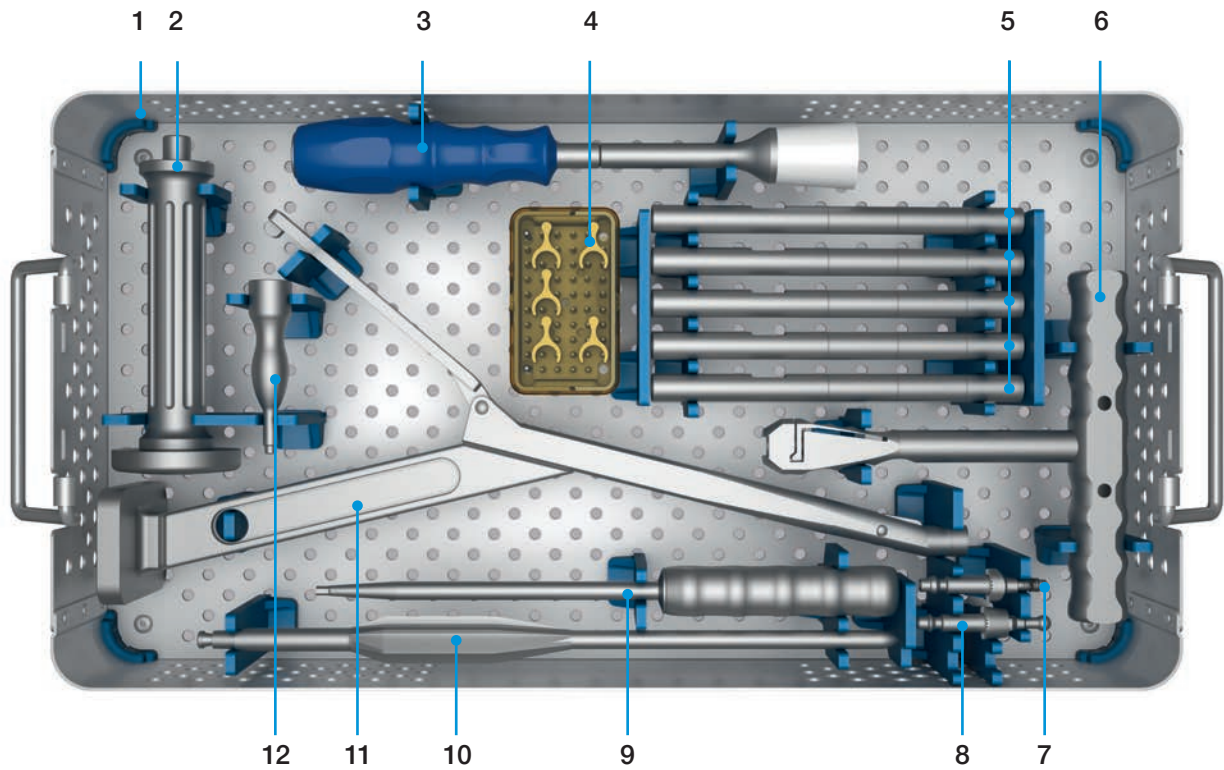

	REF	Description	Qty
1	136-031/00	Basic Instrument Set, Tray only	1
2	136-210/01	Detachable Handle	1
3	175-360	Head Impactor	1
4	136-204/02	Sleeve Stopper	5
5	136-204/01	Reamer Sleeve	5
6	15-6053/00	T-Handle	1
7	136-202/02	Implant Adapter	1
8	136-202/01	Trial Adapter	1
9	136-203/00	Hex Screwdriver, 3.5mm, with slim tip	1
10	136-200/00	Start Reamer	1
11	136-210/00	Impactor	1
12	136-202/03	Stem Adapter for Extraction	1

136-010/00 MP Monoblock Hip System, Reamers, complete

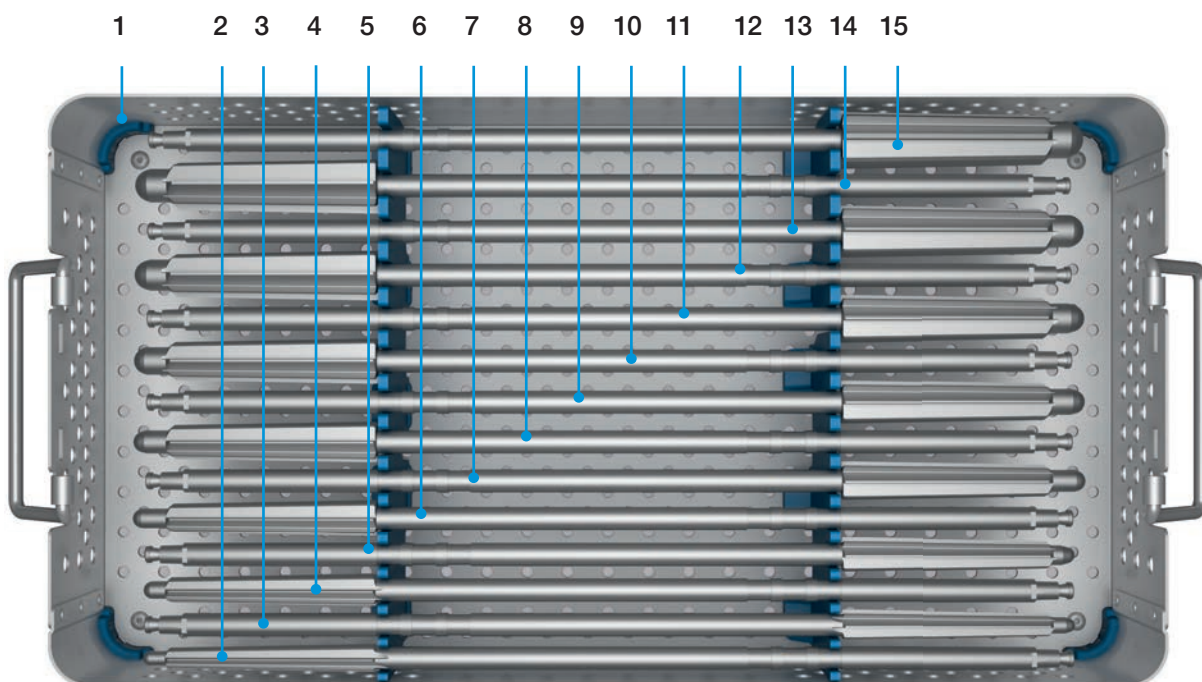

	REF	Description	Diameter mm	Qty
1	136-011/00	Instrument Tray, only		1
2	134-500/00	Reamer	12	1
3	134-500/07	Reamer	13	1
4	134-500/01	Reamer	14	1
5	134-500/08	Reamer	15	1
6	134-500/02	Reamer	16	1
7	134-500/09	Reamer	17	1
8	134-500/03	Reamer	18	1
9	134-500/10	Reamer	19	1
10	134-500/04	Reamer	20	1
11	134-500/11	Reamer	21	1
12	134-500/13	Reamer	22	1
13	134-500/14	Reamer	23	1
14	134-500/12	Reamer	24	1
15	134-500/06	Reamer	25	1

136-020/00 MP Monoblock Hip System, Trial Stems, complete

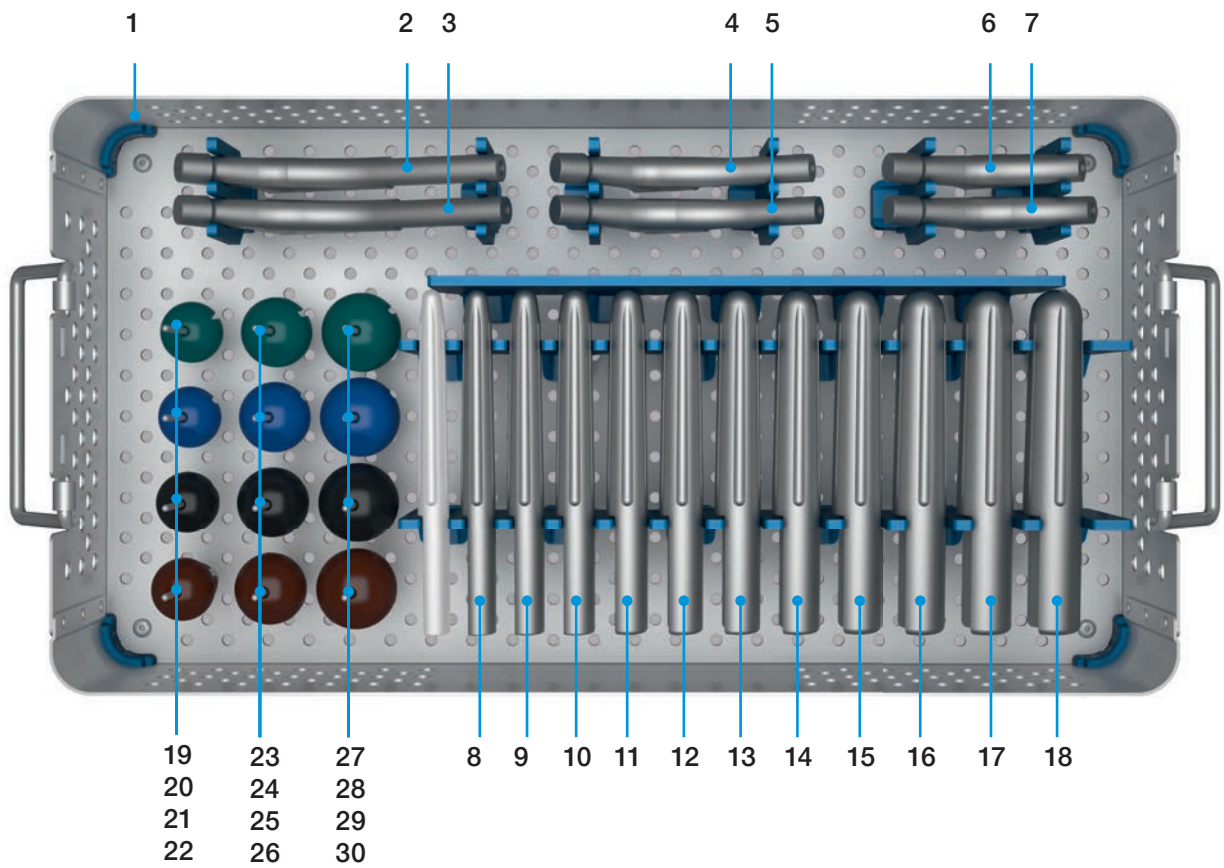

136-020/00 MP Monoblock Trial Stems, complete

	REF	Description	mm	Size
1	136-021/00	Instrument Tray, only		
2	136-102/38	Trial Neck 225 std offset, including Screw 136-225/00	for length 225	
3	136-102/46	Trial Neck 225 lateralized, including Screw 136-225/00	for length 225	
4	136-101/38	Trial Neck 195 std offset, including Screw 136-195/00	for length 195	
5	136-101/46	Trial Neck 195 lateralized, including Screw 136-195/00	for length 195	
6	136-100/38	Trial Neck 165 std offset, including Screw 136-165/00	for length 165	
7	136-100/46	Trial Neck 165 lateralized, including Screw 136-165/00	for length 165	
8	136-115/00	Trial Stem	size 15	
9	136-116/00	Trial Stem	size 16	
10	136-117/00	Trial Stem	size 17	
11	136-118/00	Trial Stem	size 18	
12	136-119/00	Trial Stem	size 19	
13	136-120/00	Trial Stem	size 20	
14	136-121/00	Trial Stem	size 21	
15	136-122/00	Trial Stem	size 22	
16	136-123/00	Trial Stem	size 23	
17	136-124/00	Trial Stem	size 24	
18	136-125/00	Trial Stem	size 25	
19	132-928/01	Trial Head	Ø 28	S
20	132-928/02	Trial Head	Ø 28	M
21	132-928/03	Trial Head	Ø 28	L
22	132-928/04	Trial Head	Ø 28	XL
23	132-932/01	Trial Head	Ø 32	S
24	132-932/02	Trial Head	Ø 32	M
25	132-932/03	Trial Head	Ø 32	L
26	132-932/04	Trial Head	Ø 32	XL
27	132-936/01	Trial Head	Ø 36	S
28	132-936/02	Trial Head	Ø 36	M
29	132-936/03	Trial Head	Ø 36	L
30	132-936/04	Trial Head	Ø 36	XL

Additional Instruments

REF	Description
130-622/01	Impactor curved
317-661	Slap Hammer
175-940/11	Plastic trial head 40 S
175-940/12	Plastic trial head 40 M
175-940/13	Plastic trial head 40 L
175-940/14	Plastic trial head 40 XL

X-ray Templates for MP Monoblock

Taper 12/14, 110% actual size

REF	Length (mm)	CCD angle	Diameter (mm)	Version
136-061/00	165-225	131, 126	15	standard, lateralized
136-062/00	165-225	131, 126	16	standard, lateralized
136-063/00	165-225	131, 126	17	standard, lateralized
136-064/00	165-225	126	18, 19	lateralized
136-065/00	165-225	126	20, 21	lateralized
136-066/00	195-225	126	22, 23	lateralized
136-067/00	225	126	24, 25	lateralized

Instructions for Cleaning and Maintenance

Specific instructions for instruments are available on request from info@linkbio.com

Additional Literature



For more information please register for our LINK Media Library (link-ortho.com)

The MP Monoblock Hip Prosthesis is indicated for patients with mobility limiting diseases, fractures or defects of the hip joint or proximal femur which cannot be treated by conservative or osteosynthetic procedures. The MP Monoblock Hip Prosthesis is indicated for the following conditions:

- Revision of loosened femoral prosthesis components involving extensive bone resorption of the proximal femur and widening of the medullary cavity or marked thinning of proximal femoral cortical bone the fixation of a new standard prosthesis is not possible
- Revision of loosened femoral prosthesis components by peri-/subprosthetic fracture

The device is intended for cementless use.

Possible risks and side effects

Surgery-related risks and side effects:

- Blood loss, allogenic /autologous blood transfusions
- Swelling / haematomas
- Thrombosis / embolism / heart attack
- Impaired wound healing
- Infections
- Muscle and nerve damage
- Damage to blood vessels
- Postoperative pain
- Complications associated with the anaesthesia applied
- Postoperative calcification

Implant-related risks and side effects:

- Intraoperative fractures
- Periprosthetic infection
- Allergic reactions to implant components and abraded particles
- Implant fractures / ceramic material fractures
- Implant loosening or subsidence
- Implant malpositioning / misalignment
- Reduced range of motion
- Luxation of joint components
- Discrepancies in the lengths of the extremities
- Premature wear and tear - reoperation
- Postoperative pain, e.g. thigh pain
- Protrusion / Arrosion

Please note the following regarding the use of our implants:

1. Choosing the right implant is very important.

The size and shape of the human bone determines the size and shape of the implant and also limits the load capacity. Implants are not designed to withstand unlimited physical stress. Demands should not exceed normal functional loads.

2. Correct handling of the implant is very important.

Under no circumstances should the shape of a finished implant be altered, as this shortens its life span. Our implants must not be combined with implants from other manufacturers.

The instruments indicated in the Surgical Technique must be used to ensure safe implantation of the components.

3. Implants must not be reused.

Implants are supplied sterile and are intended for single use only. Used implants must not be used again.

4. After-treatment is also very important.

The patient must be informed of the limitations of the implant. The load capacity of an implant cannot compare with that of healthy bone!

5. Unless otherwise indicated, implants are supplied in sterile packaging.

Note the following conditions for storage of packaged implants:

- Avoid extreme or sudden changes in temperature.
- Sterile implants in their original, intact protective packaging may be stored in permanent buildings up until the "Use by" date indicated on the packaging.
- They must not be exposed to frost, dampness or direct sunlight, or mechanical damage.
- Implants may be stored in their original packaging for up to 5 years after the date of manufacture. The "Use by" date is indicated on the product label.
- Do not use an implant if the packaging is damaged.

6. Traceability is important.

Please use the documentation stickers provided to ensure traceability.

7. Further information on the material composition is available on request from the manufacturer.

Follow the instructions for use!

Waldemar Link GmbH & Co. KG, Hamburg

All content in this catalog, including text, pictures and data, is protected by law. Every instance of use, whether in part or in whole and which is not permitted by law, is subject to our prior consent. In particular, this applies to the reproduction, editing, translation, publishing, saving, processing, or passing on of content stored in databases or other electronic media and systems, in any manner or form. The information in the catalogs is solely intended to describe the products and does not constitute a guarantee.

The Surgical Technique described has been written to the best of our knowledge and belief, but it does not relieve the surgeon of his/her responsibility to duly consider the particularities of each individual case.

Waldemar Link GmbH & Co. KG and/or other corporate affiliated entities own, use or have applied for the following trademarks in many jurisdictions: LINK, MP, PoroLink, Tilastan-S

Other trademarks and trade names may be used in this document to refer to either the entities claiming the marks and/or names or their products and are the property of their respective owners.

This publication is intended for distribution in the U.S. only